

**S T A R T E R M O T O R S**

<b>T Y P E</b>	AZD	AZE	AZF	AZG	AZJ
----------------	-----	-----	-----	-----	-----



**Iskra**

Iskra Avtoelektrika d.d.



## DIRECT DRIVE STARTER MOTORS

### APPLICATIONS

Diesel engines with 3 to 9 litre displacement.

### FEATURES

- High specific power output and efficiency.
- High cold crank capability.
- Highly efficient drive assembly for idle run of the pinion.

### DESIGN

Nose versions for specific applications on the engine.

Direct drive.

Pinion shift mechanism with solenoid, fork lever and helix.

Solenoid switch with pull-in and hold-in winding and double return spring for effective breaking of the main contacts.

Six-roller clutch and drive assembly is designed to transmit power from the starter motor to the engine.

High quality thermal resistant materials.

Support brackets of grey cast iron, nodular cast iron or die cast aluminium.

Free of asbestos, cadmium, beryllium and ammonia.

Additional dust protection with a lip seal on the pinion.

Water protection is achieved with drain holes, O-rings and rubber boot.

Oil-proof versions for wet clutch applications.

Insulated return versions are available.

### MAIN TECHNICAL DATA

Type	AZJ			
Nominal voltage (V)	12		24	
Rated power (kW)	2.7	3.0	3.2	4.0
Length (mm)	< 239.5	< 281	< 239.5	< 281
Weight (kg)	12.5	13.9	12.5	13.9
Yoke diameter (mm)	115			
Stator	4-pole windings			
Drive assembly	6 rollers			
Solenoid 12V	pull-in current < 62 A hold-in current < 14 A			
24V	pull-in current < 30 A hold-in current < 6 A			
Terminals	30 - M8, M10 31 - M8, M10 50 - M4, M6, M5, 6.3 x 0.8			
Basic protection	Protected against ingress of dust, solid foreign objects and splashing water (IP 56)			
Ambient temperature	- 40°C to + 110°C			

CROSS SECTION

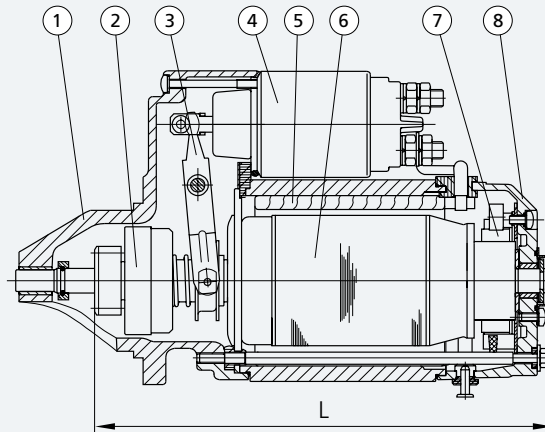

- 1. Drive end bracket • 2. Drive assembly • 3. Engaging lever • 4. Starter switch • 5. Stator • 6. Armature
- 7. Brush holder • 8. Commutator end bracket

CONNECTION DIAGRAMS

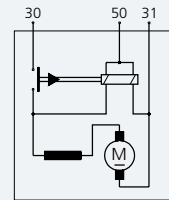
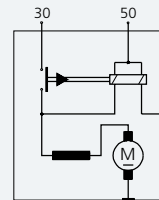

CHARACTERISTICS

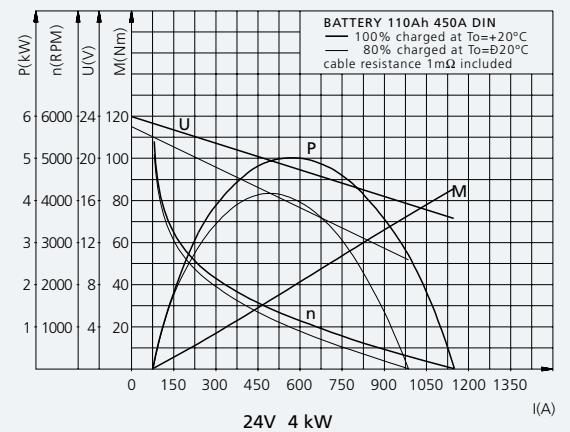
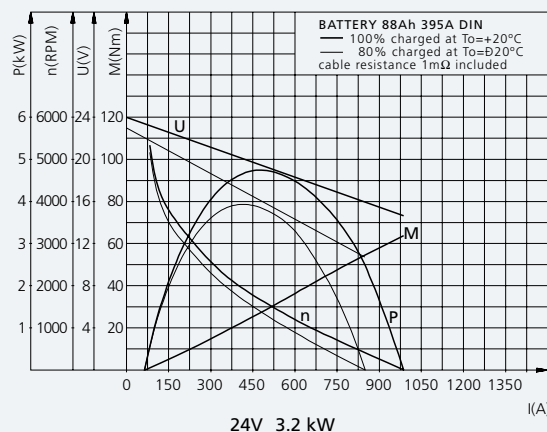
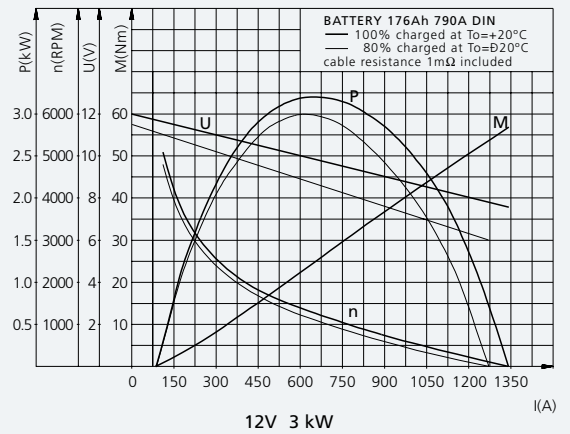
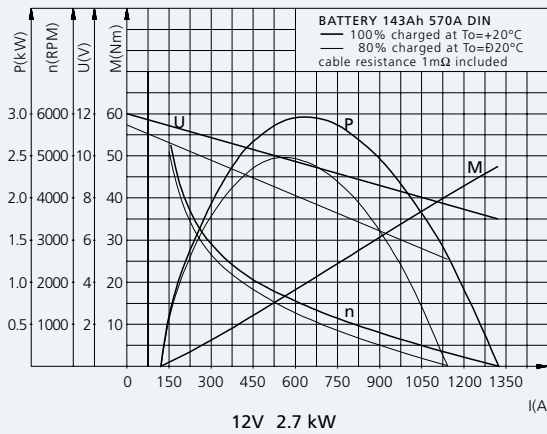

**Iskra Avtoelektrika, d. d.**

Polje 15, Slovenia,  
5290 Šempeter pri Gorici  
Tel.: +386 5 33 93 000,  
Fax: +386 5 33 93 801  
E-mail: info@iskra-ae.com  
www.iskra-ae.com

**BELARUS**

IskRa o. o. o.  
Ul. Dombrovskogo 69  
230002 Grodno  
Tel.: +375 152 487 484  
Tel/Fax: +375 152 487 485  
E-mail: iskra@mail.grodno.by

**BOSNIA AND HERZEGOVINA**

Iskra AE Komponente, d. o. o.  
Nemanjina 35  
78250 Laktaši  
Tel.: +387 51 53 07 85  
Fax: +387 51 53 53 15  
E-mail: iskra-ae@inecco.net

**BRAZIL**

Iskra do Brasil Ltda.  
Rua Testa n. 81 -  
Jardim Sao Sebastiao  
Jaguariuna - (SP)  
CEP 13820-000  
Tel.: +55 19 3837 2363  
Fax: +55 19 3837 3185  
E-mail: uros.kravos@iskra-ae.com  
www.iskra-ae.com.br

**CHINA**

Iskra Suzhou Autoelectric Co., Ltd.  
Wenzhou Industrial Zone Shuangfeng  
Taicang, Jiangsu Province  
Tel: +86 512 8160 6888  
Fax: +86 512 8160 7799  
E-mail: iskrasuzhou@iskra-ae.com  
www.iskra-ae.com.cn

Changchun Fawer  
Iskra Automotive Electrical Co., Ltd.  
No. 2258 Pudong Road  
Changchun Economic  
Technology Development Zone  
Changchun, Jilin Province  
Tel.: +86 431 461 5016  
Fax: +86 431 461 5017  
E-mail: zhj\_fa@faw.com.cn

**FRANCE**

Iskra Autoelectrique S.A.S.  
ZA du Chapeau Rouge  
56000 Vannes  
Tel.: +33 2 97 45 59 90  
Fax: +33 2 97 45 59 99  
E-mail: iskra@iskra-sa.fr  
www.iskra-ae.fr

**GERMANY**

Iskra Deutschland GmbH  
Danziger Strasse 1  
71691 Freiberg am Neckar  
Tel.: +49 7141 702 69 0  
Fax: +49 7141 702 69 33  
E-mail: info@iskra-ae.de  
www.iskra-ae.de

**GREAT BRITAIN**

Iskra UK Ltd.  
Redlands  
Ullswater Crescent, Coulsdon  
Surrey CR5 2HT  
Tel.: +44 208 668 7141  
Fax: +44 208 668 3108  
E-mail: sales@iskra-agency.co.uk  
www.iskra-ae.co.uk

**IRAN**

Iskra Autoelectric Iran JVC  
No.28, East Mirdamad Avenue  
Tehran 15469-34311  
Tel.: +98 21 2 226 237 1 - 4  
Fax: +98 21 2 226 237 6  
E-mail: info@iskra-iran.com

**ITALY**

Iskra Autel S. r. l.  
Via G. Cantore, 2  
34170 Gorizia  
Tel.: +39 0481 536 800  
Fax: +39 0481 536 810  
E-mail: info@iskra-autel.it  
www.iskra-autel.it

**RUSSIA**

Iskra Avtoelektrika  
Representative Office  
Storozhevaya str., 4,  
building 1 office 123  
111020 Moscow  
Tel.: +7 095 726 93 94  
Fax: +7 095 225 84 06  
E-mail: info@iskra-ae.ru  
www.iskra-ae.ru

Pramo Iskra o.o.o.  
Zubcovskoe shosse 21  
172387 Rzhev, Tverskaya obl.  
Representative office in Moscow  
Elektrozavodskaya str. 21  
107023 Moscow  
Tel. / Fax: +7 495 995 2512  
E-mai: iskra@pramo.ru

**SPAIN**

Iskra Autoelectrique Spain S.A.  
Calle Llobatona No. 6-D  
08840 Viladecans  
Tel.: +34 93 647 40 83  
Fax: +34 93 647 40 84  
E-mail: iskra@iskra-ae.es  
www.iskra-ae.fr/esp/

**USA**

Iskra AE Inc.  
4814 American Road  
Rockford, IL 61109  
Tel.: +1 800 474 1996  
Tel.: +1 815 874 4022  
Fax.: +1 815 874 4024  
E-mail: iskra@iskraae.com  
www.iskraae.com